

(19) World Intellectual Property Organization  
International Bureau



(43) International Publication Date  
18 November 2004 (18.11.2004)

PCT

(10) International Publication Number  
WO 2004/100156 A1

- (51) International Patent Classification<sup>7</sup>: G11B 20/10
- (21) International Application Number: PCT/KR2004/001058
- (22) International Filing Date: 7 May 2004 (07.05.2004)
- (25) Filing Language: English
- (26) Publication Language: English
- (30) Priority Data:
 

60/469,006	9 May 2003 (09.05.2003)	US
10-2003-0031958	20 May 2003 (20.05.2003)	KR
- (71) Applicant (for all designated States except US): LG ELECTRONICS INC. [KR/KR]; 20, Yoido-dong, Youngdungpo-gu, Seoul 150-721 (KR).
- (72) Inventor; and
- (75) Inventor/Applicant (for US only): PARK, Yong Cheol [KR/KR]; 215-204, Jugong APT., Wonmun-dong, Gwachon-si, Gyeonggi-do 427-740 (KR).
- (74) Agents: BAHNG, Hae Cheol et al.; Kims International Patent & Law Office, 15th Floor Yosam-building, 648-23, Yeoksam-dong, Kangnam-gu, Seoul 135-080 (KR).
- (84) Designated States (unless otherwise indicated, for every kind of national protection available): AE, AG, AL, AM, AT, AU, AZ, BA, BB, BG, BR, BW, BY, BZ, CA, CH, CN, CO, CR, CU, CZ, DE, DK, DM, DZ, EC, EE, EG, ES, FI, GB, GD, GE, GH, GM, HR, HU, ID, IL, IN, IS, JP, KE, KG, KP, KR, KZ, LC, LK, LR, LS, LT, LU, LV, MA, MD, MG, MK, MN, MW, MX, MZ, NA, NI, NO, NZ, OM, PG, PH, PL, PT, RO, RU, SC, SD, SE, SG, SK, SL, SY, TJ, TM, TN, TR, TT, TZ, UA, UG, US, UZ, VC, VN, YU, ZA, ZM, ZW.
- (84) Designated States (unless otherwise indicated, for every kind of regional protection available): ARIPO (BW, GI, GM, KE, LS, MW, MZ, NA, SD, SL, SZ, TZ, UG, ZM, ZW), Eurasian (AM, AZ, BY, KG, KZ, MD, RU, TJ, TM), European (AT, BE, BG, CH, CY, CZ, DE, DK, EE, ES, FI, FR, GB, GR, HU, IE, IT, LU, MC, NL, PL, PT, RO, SE, SI, SK, TR), OAPI (BF, BJ, CF, CG, CI, CM, GA, GN, GQ, GW, ML, MR, NE, SN, TD, TG).

Published:  
— with international search report

For two-letter codes and other abbreviations, refer to the "Guidance Notes on Codes and Abbreviations" appearing at the beginning of each regular issue of the PCT Gazette.

(54) Title: RECORDING MEDIUM HAVING DATA STRUCTURE FOR MANAGING AT LEAST A DATA AREA OF THE RECORDING MEDIUM AND RECORDING AND REPRODUCING METHODS AND APPARATUSES

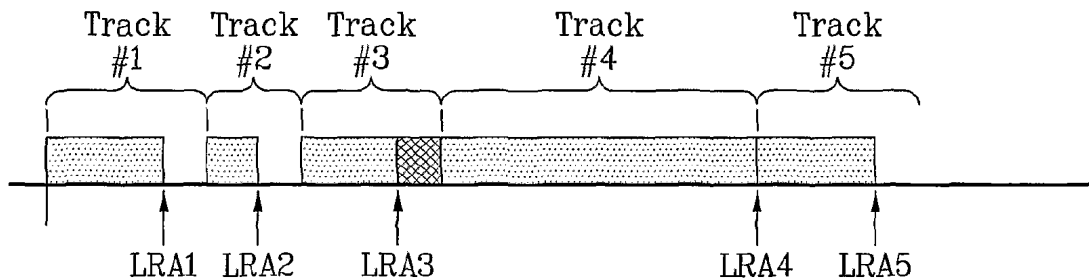

\*LRA : Last Recorded Address

(57) Abstract: The data structure on the recording medium includes a temporary defect management area storing a data block. The data block includes sequential recording information and a temporary definition structure. The sequential recording information provides information on continuous recording areas in the data area of the recording medium. The temporary definition structure includes at least one pointer to information in the temporary defect management area.



WO 2004/100156 A1

**RECORDING MEDIUM HAVING DATA STRUCTURE FOR  
MANAGING AT LEAST A DATA AREA OF THE RECORDING  
MEDIUM AND RECORDING AND REPRODUCING METHODS  
AND APPARATUSES**

5 **Technical Field**

The present invention relates to a recording medium having a data structure for managing at least a data area of the recording medium as well as methods and apparatuses for reproduction and recording.

10 **Background Art**

The standardization of new high-density read only and rewritable optical disks capable of recording large amounts of data has been progressing rapidly and new optical disk related products are expected to be commercially available in the near future. For example, the blu-ray disc (BD), which belongs to the next-generation  
15 HD-DVD technology, is the next-generation optical recording solution that can strikingly surpass the data recording capability of existing DVDs.

Recording on and reading from a BD uses a celadon laser having a wavelength of 405nm, which is much denser than a red laser having a wavelength of 650nm used with existing DVDs. Thus, a greater amount of data may be stored on BD than on  
20 existing DVDs.

While at least one standard related to the BD (Blu-ray Disc) has been developed, such as BD-RE (BD Rewritable disc), many other standards such as BD-WO (BD Write Once disc) are still in development. Standards such as BD-RE provide a data structure for managing defects in the data area of the recording medium. However,  
25 the BD-WO, because of its write-once nature, presents challenges not faced by existing BD standards such as BD-RE, and an effective data structure and method of managing defects is still under development for the BD-WO standard.

**Disclosure of Invention**

The recording medium according to the present invention includes a data structure for managing at least a data area of the recording medium.

In one exemplary embodiment, a temporary defect management area of the recording medium stores a first data block that includes sequential recording information and a temporary definition structure. The sequential recording information provides information on continuous recording areas in the data area of the recording medium. The temporary definition structure includes at least one pointer to information in the temporary defect management area.

10 In one embodiment, the sequential recording information includes a header, information entries for each continuous recording area and a terminator. The header identifies the sequential recording information as sequential recording information. Each information entry provides information on an associated continuous recording area, and the terminator indicates an end of the sequential recording information.

15 In one embodiment, the header information indicates a number of the continuous recording areas and a number of the continuous recording areas open for recording. In an example embodiment, each information entry indicates a status of the associated continuous recording area, indicates a starting physical sector number of the associated continuous recording area, and indicates a last recording address of the associated continuous recording area.

20 The present invention further provides apparatuses and methods for recording and reproducing the data structure according to the present invention.

**Brief Description of Drawings**

25 The above features and other advantages of the present invention will be more clearly understood from the following detailed description taken in conjunction with the accompanying drawings, in which:

Fig. 1 illustrates the different kinds of basic tracks of a write-once optical disc according to an example embodiment of the present invention;

Figs. 2A and 2B illustrate a data structure of the write-once optical disc, and more specifically, the temporary disc management information according to an  
5 embodiment of the present invention;

Fig. 3 illustrates a comparison of the disc management information of a conventional rewritable optical disc to the disc management information of the present invention;

Figs. 4 and 5 illustrate two example embodiments of a method of updating the track  
10 information according to the present invention; and

Fig. 6 illustrates an embodiment of a recording and reproducing apparatus according to the present invention.

### **Best Mode for Carrying Out the Invention**

15 In order that the invention may be fully understood, exemplary embodiments thereof will now be described with reference to the accompanying drawings. For convenience, a write-once optical Blu-ray disc will be used as an example of a write-once recording medium in the exemplary embodiments.

#### **Kinds of Tracks and Data Structure of the Recording Medium**

20 Referring to Figs. 1, 2A-2B and 3, the kinds of tracks and physical structure of the disc according to an example embodiment of the of the present invention will be described. A continuous recording area in which data is sequentially recorded will be referred to as a track in this disclosure. Fig. 1 illustrates the different kinds of  
25 basic tracks of a write-once optical disc according to an example embodiment of the present invention. More specifically, Fig. 1 illustrates a plurality of continuous recording areas or tracks having different status assuming use of the write-once disc

over a period of time. As shown, tracks 1 and 2 correspond to open tracks that while storing data in a first area thereof, each have a later area on which additional recording is possible. The tracks 3 and 4 correspond to complete or closed tracks that are completely filled (track 4) or are closed for further recording (track 3). As shown by track 3, when a track having an unrecorded area is closed such that no further recording in the track is permitted, the unrecorded area is padded with zeros (shown as a hatched portion in Fig. 1) and changed to be a complete track. Track 3 is different from track 4 in that point.

Track 5 provides an example of the last track that includes area on which additional recording is possible. This track is called an intermediate track. Accordingly, there are three kinds of tracks – open, closed and intermediate.

Each of the tracks has a last recorded address (LRA) regardless of the kind of the track. The LRA is the last address at which actual data was recorded in the track. Accordingly, with respect to track 3, the position (or address) before the track 3 was padded with zeros is the LRA for track 3 (LRA3). More specifically, assuming the unit for recording data on the optical disc is a cluster, and there are 32 sectors in one cluster, if less than the 32 sectors have data recorded therein, then the remaining sectors are padded with zeros. The last sector address before the padding is the LRA. For each of the open and intermediate tracks, but not the closed tracks, a next writable address (NWA) indicating the next address into which data may be written may be determined. The NWA is obtained from the LRA as the next sector address following the LRA.

Figs. 2A and 2B illustrate a data structure of the write-once optical disc, and more specifically, temporary disc management information according to an embodiment of the present invention. The configuration of the write-once optical disc shown in Fig. 2A is described in detail in Korea Patent Application no. 2003-15634.

As shown, the write-once optical disc in this example is a single layer disc that has one recording layer. The disc includes spare areas (ISA0/ISA1) for recording data that could not be recorded in the main data area because of defects in the main data area (e.g., physical defects). Information for managing the replacement of defect portions of the data area with portions of the spare area is recorded in a temporary defect management area or areas (TDMA).

In general, a rewritable, as opposed to a write-once, optical disc has a limited defect management area (DMA) because data can be written and erased from the DMA repeatedly. A write-once optical disc needs a larger amount of to manage defects since data can be written only once and not erased. Accordingly, the TDMA is used for recording the defect management information as this information changes during use of the optical disc. Once the disc is complete, the last version of the defect management information is copied from the TDMA to a DMA on the write-once optical disc.

Referring to Fig. 2A, the TDMA includes TDMA1 allocated to a lead-in area having a fixed size and TDMA2 allocated to spare area OSA0. The TDMA2 has a size interworking with the size of the spare area. For example, the size of the spare area OSA0 is  $N \times 256$  cluster, of which the TDMA2 forms  $P$  clusters. The number of clusters  $P$  may be determined according to the expression  $P = (N \times 256) / 4$ . In each TDMA, temporary defect management information in the form of a temporary defect list (TDFL), a temporary disc definition structure (TDDS), and disc use status information may be recorded.

As discussed above, when a defect area exists in the data area, a spare area (ISA0/OSA0) is substituted for the defect area. The TDFL provides information to manage this process in the form of a list. For example, the list indicates the defect area and the spare area replacing the defect area. According to one embodiment of the present invention, the size of the TDFL, varies from 1 to 4 clusters depending on

the amount of information in the TDFL. By contrast, according to one example embodiment of the present invention, the amount of space devoted to the TDDS remain fixed at one cluster. According to this embodiment, this data block includes the TDDS and disc usage status information as discussed in detail below with  
5 respect to Figs 3 and 2B.

Referring first to Fig. 3, the disc management information of the conventional rewritable optical disc will be compared with the contents included in the TDDS of the present invention.

In the case of a rewritable optical disk, the DDS consumes a very small portion of  
10 the disc - about 60 bytes of one cluster (one cluster having 32 sectors). The remaining area of the cluster is set by 'zero padding'. However, according to this embodiment of the present invention, the remaining area as well as the area (60 bytes) used in the conventional rewritable optical disk is used as disc management information. Accordingly, in the TDDS of the present invention, information  
15 particular to a write-once optical disc as well as DDS as used in the conventional rewritable optical disc is recorded sequentially in one sector (2048 bytes). For example, the information particular to the write-once optical disc may be position information of the latest TDFL.

As shown in Fig. 2A and 3, the sequential recording or, more particularly, the track  
20 information according to an embodiment of the present invention is recorded on the remaining 31 sectors of one cluster that includes the TDDS. Alternatively, the track information may be configured in 31 sectors in the front of TDDS and the TDDS may be configured on the last, 32<sup>nd</sup> sector.

Accordingly, the TDDS as used in this disclosure should be construed broadly as  
25 described above and not as a term defined according to one particular standard.

#### Data Structure of Track Information on the Recording Medium

First, the present invention does not limit the number of the open tracks. Accordingly, there may exist a plurality of open tracks and complete tracks. The present invention provides a data structure on the recording medium for managing this potential in an efficient manner. An embodiment of this track information data structure will now be described in detail with respect to Fig. 2B.

As shown, the sequential recording, or more particularly, the track information includes three parts: a header for indicating that the data structure provides track information, a track information list providing the track information, and an terminator indicating an end of the track information.

The header is positioned at the front portion of the track information and includes a 'track information structure identifier' field indicating that information following the identifier is track information. The next indicator 'track information format' indicates the format of the track information. This is followed by a 'layer number (0 or 1)' field representing the recording layer to which the track information corresponds. While the example thus far has been for a single sided, single recording layer write-once optical disc, the optical disc may have multiple recording layers and/or be double sided.

The header further includes a 'total number of tracks' field representing the number tracks in the data area of the recording layer to which the track information corresponds, and 'total number of open tracks' field representing the number of the open tracks in this data area. Before reading the track information list, the total track information may be confirmed.

The track information list is recorded after the header and will be described in greater detail below. The track information list terminator represents the end of the track information. Accordingly, the track information includes a header, track information list and a terminator recorded in series.



An example embodiment of the track information list will now be described in more detailed. The track information list includes one entry for each track in the corresponding data area of the disc. Each entry may be allocated to, for example, 8 bytes. This track information entry includes track status information, a first  
5 address of the corresponding track and the last recorded address information of the track.

The track status information indicates the kind of track – open, closed or intermediate, and may be represented by 4 bits as shown in Fig 3B. In this embodiment of the present invention, an open track in which additional recording is  
10 possible is indicated by ‘0000b’ as the track status information. An intermediate track is indicated by ‘0001b’ as the track status information, and a complete track, in which additional recording is not permitted, is indicated by ‘1000b’ as the track status information. The track status information is represented as specific bits as described above to aid in sorting the track information list entries as described later  
15 in this disclosure.

In the example of Fig. 2B, the first address information of an entry is a ‘start physical sector number (PSN) of track’ field. This field provides the sector address of the first sector forming the track. The last recorded address information in the example of Fig. 3B is the LRA of the track. Accordingly, if one entry is read, the  
20 kind of track, the start position and LRA of the track may be determined.

The track status information in each entry may also include a session start status (e.g., one of the bits in the track status information in each entry may be used as the session start bit). The session status indicates if the track is the first track or not the first track in a session. Here, the clustering of tracks into a group is called a session.

### Track Information Update Method

When to update the track information may be a design parameter established according to the system or system designer. However, examples of events triggering update will be described in detail below.

- 5 When a new track is generated or a track is closed, since the track information is newly generated, the track information may be updated. When a disc is ejected from a driver or the power to the driver is turned off, use of the disc is stopped at least temporarily. At these times, the track information is updated.

10 Figs. 4 and 5 illustrate two example embodiments of a method of updating the track information according to the present invention. As shown in Fig. 4, the track information in a preceding step and the track information to be updated now are separate and recorded separately. In this method, the track information previously recorded is included in the current recording such that the track information is recorded cumulatively.

- 15 More specifically, to record the track information updated at time  $n + 1$ , the track information recorded at time  $n$  and the track information at time  $n+1$  are recorded sequentially. In other words, the track information in the preceding track recording step is included, but recorded separately from current track information. Similarly when updating the track information at time  $n + 2$ , the track information recorded at  
20 time  $n$  and  $n+1$  is included, but recorded separately.

The advantage of this embodiment is that the contents of the track information at each stage of disc usage is recorded in sequential order. It is easy to confirm the usage status of the disc. If only the latest track information is recorded, it would be more difficult to access the previous track information and require a longer time to  
25 access this information.

Fig. 5 illustrates another embodiment of a method of updating the track information according to the present invention. The track information previously recorded and

the track information to be updated now are included and recorded cumulatively. However, prior to recording, the track information list is sorted and recorded in a specific order.

More specifically, to record the track information updated at time  $n + 1$ , the track information recorded at time  $n$  and the track information to be updated now at time  
5  $n+1$  are considered as one track information list and sorted. The sorted version of the track information is then recorded in a specific order.

For example, the track information list entries may be sorted by track status (i.e., the kind of track). Using the format of the track status information described above with  
10 respect to Fig. 2B as an example, the entries of the open tracks that have '0000b' as track status information come first. Next, entries of the complete tracks that have '1000b' as the track status information are recorded, and last, the entries of the intermediate track that have '0001b' as track status information are recorded. For entries having the same track status information, the entries are sorted by the first  
15 address information such that the entries having smaller addresses are recorded first.

Another method is also possible. For example at first the track information list entries may be sorted by the first address information such that the entries having smaller addresses are recorded first. It should be understood that these are merely  
20 examples of the sorting that may take place, and that a system designer may adopt other basis for sorting that fall within the spirit and scope of the present invention.

The advantage of this embodiment of the present invention is that information on the tracks in a disc are sorted according to their kind so that the information related to a kind of track (e.g., open track) may be easily obtained. Also, because the track information for each track is recorded in the updating, the track information for the  
25 data area is easily and quickly accessible.

The two embodiments described above are complementary to each other. The system or user may select and use the method suitable to their environment.

Fig. 6 illustrates a schematic diagram of an embodiment of an optical disk recording and reproducing apparatus according to the present invention. As shown, an encoder 9 receives and encodes data (e.g., still image data, audio data, video data, etc.). The encoder 9 outputs the encoded data along with coding information and stream attribute information. A multiplexer 8 multiplexes the encoded data based on the coding information and stream attribute information to create, for example, an MPEG-2 transport stream. A source packetizer 7 packetizes the transport packets from the multiplexer 8 into source packets in accordance with the audio/video format of the optical disk. As shown in Fig. 6, the operations of the encoder 9, the multiplexer 8 and the source packetizer 7 are controlled by a controller 10. The controller 10 receives user input on the recording operation, and provides control information to encoder 9, multiplexer 8 and the source packetizer 7. For example, the controller 10 instructs the encoder 9 on the type of encoding to perform, instructs the multiplexer 8 on the transport stream to create, and instructs the source packetizer 7 on the source packet format. The controller 10 further controls a drive 3 to record the output from the source packetizer 7 on the optical disk.

The controller 10 also creates the navigation and management information for managing reproduction of the data being recorded on the optical disk. For example, the controller 10 controls the drive 3 to record one or more of the data structures of Figs. 1-3 on the optical disk.

During reproduction or further recording operations, the controller 10 may control the drive 3 to reproduce this data structure. Based on the information contained therein, as well as user input received over the user interface (e.g., control buttons on the recording and reproducing apparatus or a remote associated with the apparatus), the controller 10 controls the drive 3 to reproduce and/or record data from/to the optical disk as discussed in detail above.

Reproduced source packets are received by a source depacketizer 4 and converted into a data stream (e.g., an MPEG-2 transport packet stream). A demultiplexer 5 demultiplexes the data stream into encoded data. A decoder 6 decodes the encoded data to produce the original data that was fed to the encoder 9. During reproduction, 5 the controller 10 controls the operation of the source depacketizer 4, demultiplexer 5 and decoder 6. The controller 10 receives user input on the reproducing operation, and provides control information to decoder 6, demultiplexer 5 and the source packetizer 4. For example, the controller 10 instructs the decoder 9 on the type of decoding to perform, instructs the demultiplexer 5 on the transport stream to 10 demultiplex, and instructs the source depacketizer 4 on the source packet format.

While Fig. 6 has been described as a recording and reproducing apparatus, it will be understood that only a recording or only a reproducing apparatus may be provided using those portions of Fig. 6 providing the recording or reproducing function.

### **Industrial Applicability**

15 The write-once optical disc management data structure and method of recording and reproducing this data structure as well as updating the management data provide information regarding the use of the recording medium to sequentially store data in continuous recording areas (e.g., tracks). This data structure and these methods remain applicable for the case where the number of the open tracks, in which 20 additional recording is possible, is not limited.

The data structure for and method for managing at least a data area of a high-density recording medium in accordance with embodiments of the present invention enables an efficient and progressive use of a write-once recording medium such as BD-WO. As apparent from the above description, the present invention also provides 25 apparatuses for recording a data structure on a high density recording medium for managing at least a data area of the recording medium.

While the invention has been disclosed with respect to a limited number of embodiments, those skilled in the art, having the benefit of this disclosure, will appreciate numerous modifications and variations there from. For example, while described with respect to a Blu-ray Write-Once optical disk in several instances, the present invention is not limited to this standard of optical disk or to optical disks. It is intended that all such modifications and variations fall within the spirit and scope of the invention.

## Claims

1. A recording medium having a data structure for managing a data area of a recording medium, comprising:
  - 5 a temporary defect management area storing a first data block, the first data block including sequential recording information and a temporary definition structure, the sequential recording information providing information on continuous recording areas in the data area of the recording medium, the temporary definition structure including at least one pointer to information in the temporary defect  
10 management area.
  2. The recording medium of claim 1, wherein the first data block has a size of at least one cluster.
  - 15 3. The recording medium of claim 2, wherein one sector of the first data block is devoted to the temporary definition structure and at most 31 sectors of the first data block are devoted to the sequential recording information.
  4. The recording medium of claim 3, wherein a first sector of the sequential  
20 recording information is located adjacent to the temporary definition structure.
  5. The recording medium of claim 1, wherein the sequential recording information includes a header, information entries for each continuous recording area and a terminator, the header identifying the sequential recording information as sequential  
25 recording information, each information entry providing information on an associated continuous recording area, and the terminator indicating an end of the sequential recording information.

6. The recording medium of claim 5, wherein the header information indicates a number of the continuous recording areas.
7. The recording medium of claim 6, wherein the header information indicates a number of the continuous recording areas open for recording.
8. The recording medium of claim 5, wherein the header information indicates a number of the continuous recording areas open for recording.
9. The recording medium of claim 5, wherein each information entry indicates whether the associated continuous recording area is a first continuous recording area in a group of continuous recording areas.
10. The recording medium of claim 5, wherein each information entry indicates whether the associated continuous recording area is open for recording.
11. The recording medium of claim 5, wherein each information entry indicates a starting physical sector number of the associated continuous recording area.
12. The recording medium of claim 5, wherein each information entry indicates a last recording address of the associated continuous recording area.
13. The recording medium of claim 5, wherein each information entry indicates a status of the associated continuous recording area, indicates a starting physical sector number of the associated continuous recording area, and indicates a last recording address of the associated continuous recording area.



14. The recording medium of claim 13, wherein the status indicates whether the associated continuous recording area is a start of a group of continuous recording areas.

5 15. The recording medium of claim 1, wherein the temporary definition structure includes a pointer to a temporary defect list in the temporary defect management area, the temporary defect list indicating defects in the data area.

16. The recording medium of claim 1, wherein the temporary defect management  
10 area comprises:

a second data block, the second data block including a later recorded sequential recording information as compared to the first data block, the later recorded sequential recording information including the sequential recording information of the first data block and new sequential recording information.

15

17. The recording medium of claim 16, wherein

the sequential recording information in the first and second data blocks each include a header, information entries for each continuous recording area and a terminator, the header identifying the sequential recording information as  
20 sequential recording information, each information entry providing information on an associated continuous recording area, and the terminator indicating an end of the sequential recording information; and  
the information entries in the sequential recording information in the first and second data blocks are sorted by entry into the sequential recording  
25 information.

18. The recording medium of claim 16, wherein

the sequential recording information in the first and second data blocks each include a header, information entries for each continuous recording area and a terminator, the header identifying the sequential recording information as sequential recording information, each information entry providing information on an associated continuous recording area, and the terminator indicating an end of the sequential recording information; and

5 each information entry in the sequential recording information in the first and second data blocks includes a status indicator indicating a status of the associated continuous recording area; and

10 the information entries in the sequential recording information in the first and second data blocks are sorted by status.

19. A recording medium having a data structure for managing a data area of a recording medium, comprising:

15 a temporary defect management area storing the sequential recording information, the sequential recording information including a header, information entries for each continuous recording area in the data area and a terminator, the header identifying the sequential recording information as sequential recording information, each information entry providing information on an associated

20 continuous recording area, and the terminator indicating an end of the sequential recording information.

20. The recording medium of claim 19, wherein the header information indicates a number of the continuous recording areas.

25

21. The recording medium of claim 20, wherein the header information indicates a number of the continuous recording areas open for recording.

22. The recording medium of claim 19, wherein the header information indicates a number of the continuous recording areas open for recording.
23. The recording medium of claim 19, wherein each information entry indicates  
5 whether the associated continuous recording area is a first continuous recording area.
24. The recording medium of claim 19, wherein each information entry indicates whether the associated continuous recording area is open for recording.
- 10 25. The recording medium of claim 19, wherein each information entry indicates a starting physical sector number of the associated continuous recording area.
26. The recording medium of claim 19, wherein each information entry indicates a last recording address of the associated continuous recording area.  
15
27. The recording medium of claim 19, wherein each information entry indicates a status of the associated continuous recording area, indicates a starting physical sector number of the associated continuous recording area, and indicates a last recording address of the associated continuous recording area.  
20
28. The recording medium of claim 27, wherein the status indicates whether the associated continuous recording area is a start of a group of continuous recording areas.
- 25 29. A method of recording management data on a recording medium, comprising:  
  
recording a data block in a temporary defect management area, the data block

including sequential recording information and a temporary definition structure, the sequential recording information providing information on continuous recording areas in the data area of the recording medium, the temporary definition structure including at least one pointer to information in  
5 the temporary defect management area.

30. A method of reproducing data from a recording medium, comprising:

reproducing at least a portion of data recorded on the recording medium based on a data block recorded in a temporary defect management area of the recording medium, the data block including sequential recording information  
10 and a temporary definition structure, the sequential recording information providing information on continuous recording areas in the data area of the recording medium, the temporary definition structure including at least one pointer to information in the temporary defect management area.

15

31. An apparatus for recording management data on a recording medium, comprising:

a driver for driving an optical recording device to record data on the recording medium; and

20

a controller for controlling the driver to record a data block in a temporary defect management area, the data block including sequential recording information and a temporary definition structure, the sequential recording information providing information on continuous recording areas in the data area of the recording medium, the temporary definition structure including at  
25 least one pointer to information in the temporary defect management area.

FIG. 1

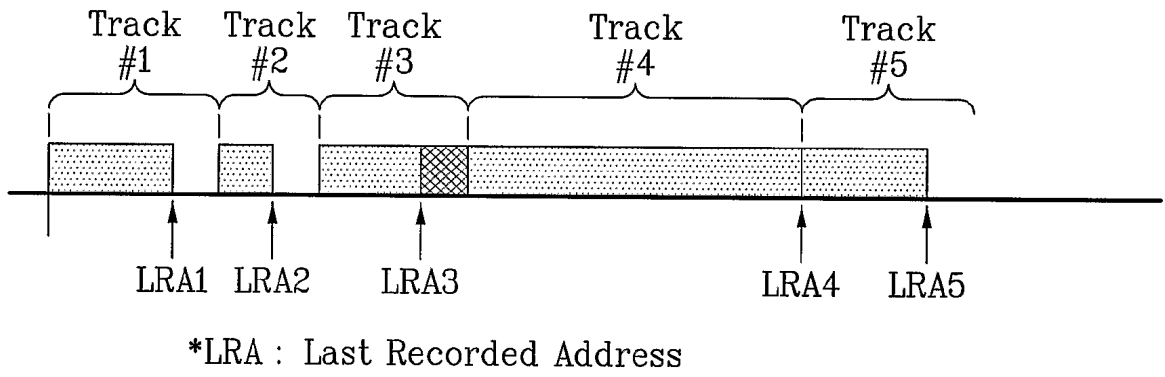

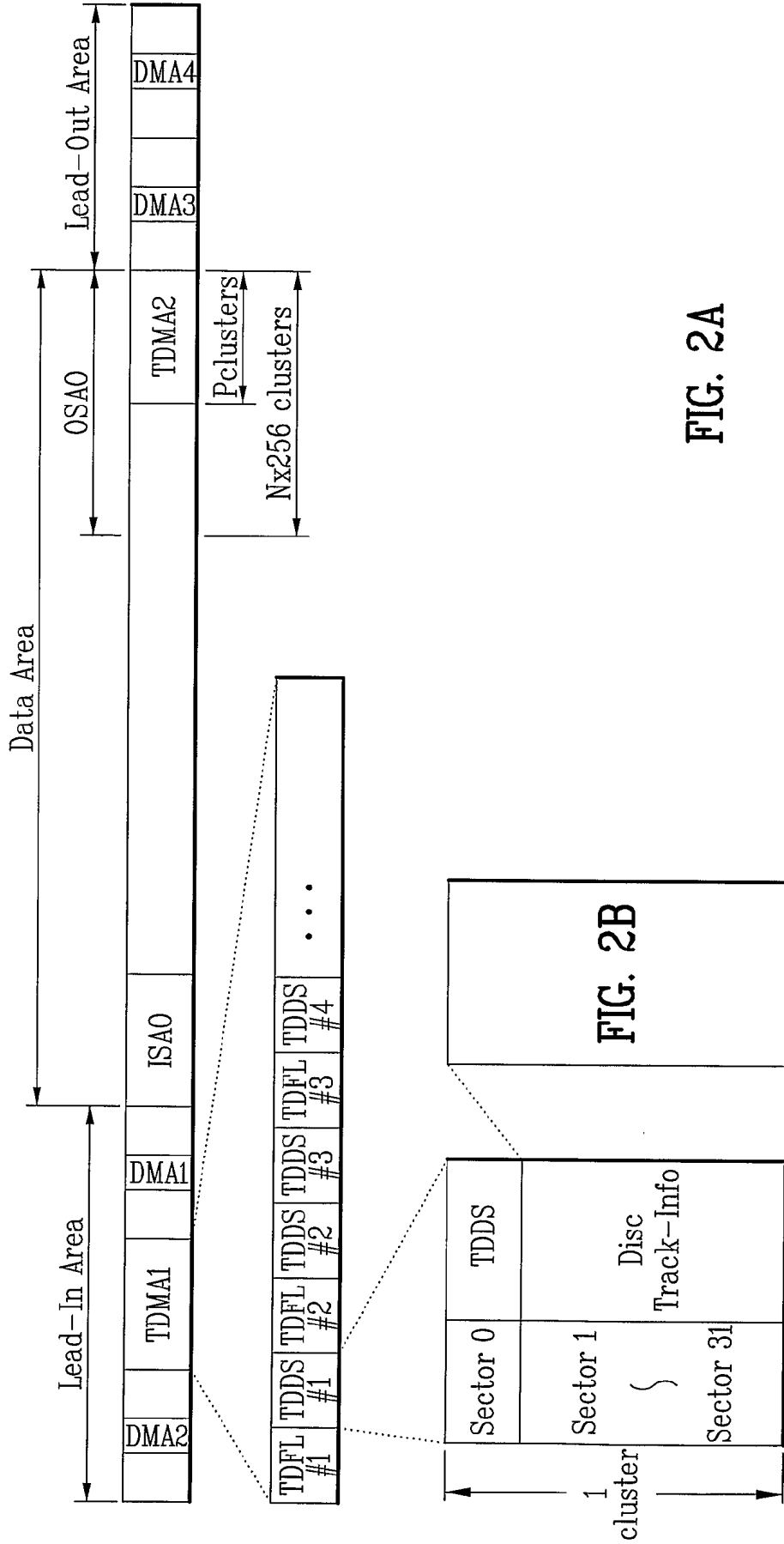

FIG. 2A

- \* DMA : Defect Management Area
- \* TDMA : Temporary DMA
- \* ISA : Inner Spare Area
- \* OSA : Outer Spare Area
- \* TDFL : Temporary Defect List
- \* TDDS : Temporary Disc Definition Structure

FIG. 2B

FIG. 2B

Byte position in Data Frame	Contents	number of bytes
0	Track Info Structure identifier	2
2	Track Info format = 00h	1
3	reserved and set to 00h	1
4	Layer number (0 or 1)	4
8	Total number of tracks	4
12	Total number of open tracks	4
16	List of Track Info	n * 8
n * 8	Track Info List Terminator	
	Reserved and set to 00h	

b63 .. b60	b59 .. b32	b31 .. b28	b27 .. b0
Track status	Start PSN of Track #n	reserved	LRA of Track #n
Track status	Start PSN of Track #n+1	reserved	LRA of Track #n+1
Track status	Start PSN of Track #n+2	reserved	LRA of Track #n+2
:	:	:	:
:	:	:	:

Track Status

0000b : Open Track

1000b : Complete Track

0001b : Intermediate Track

FIG. 3

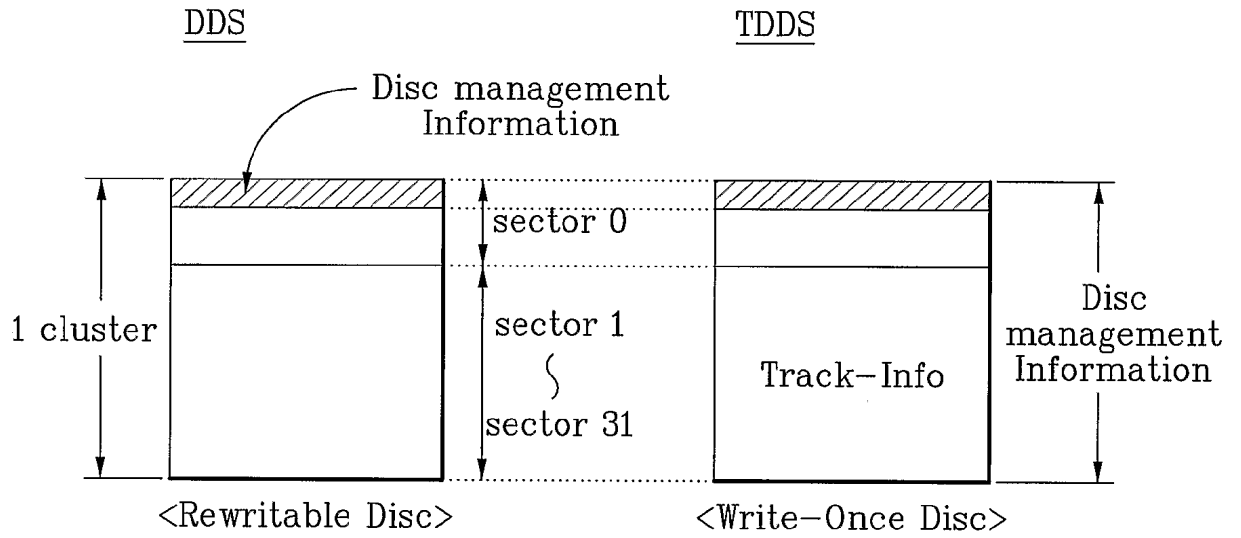

FIG. 4

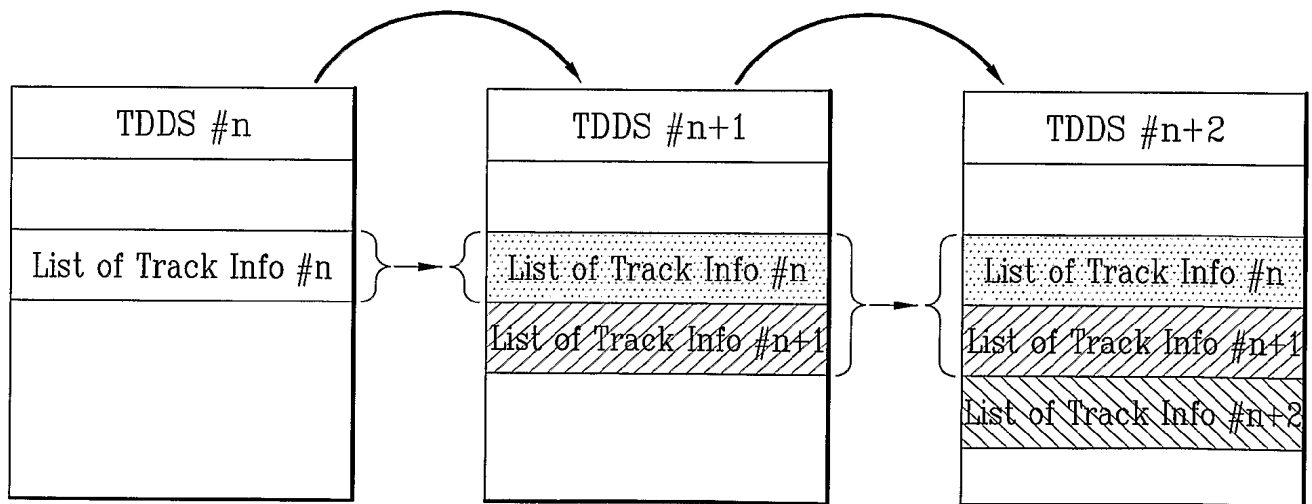



FIG. 5

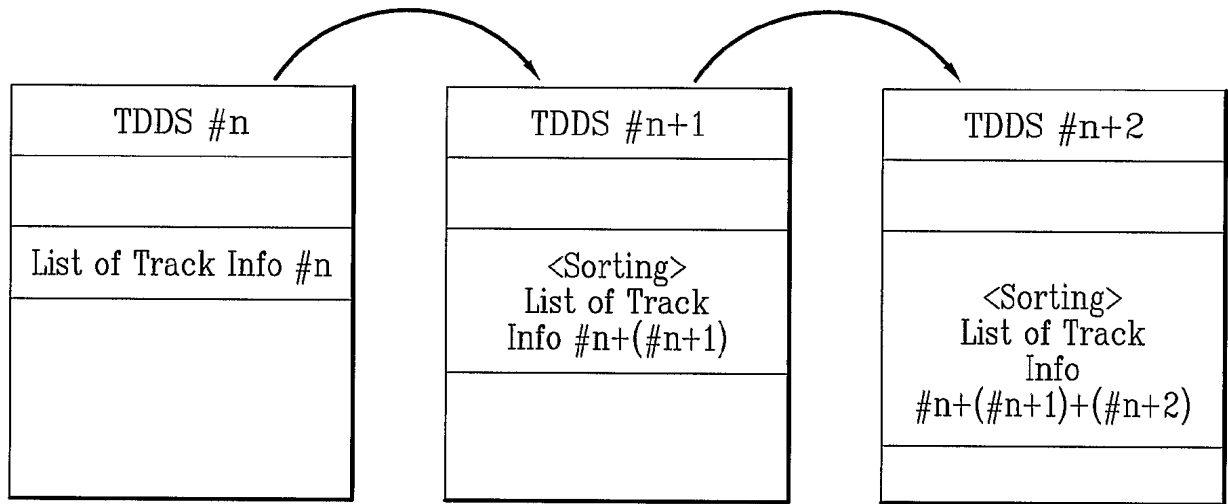
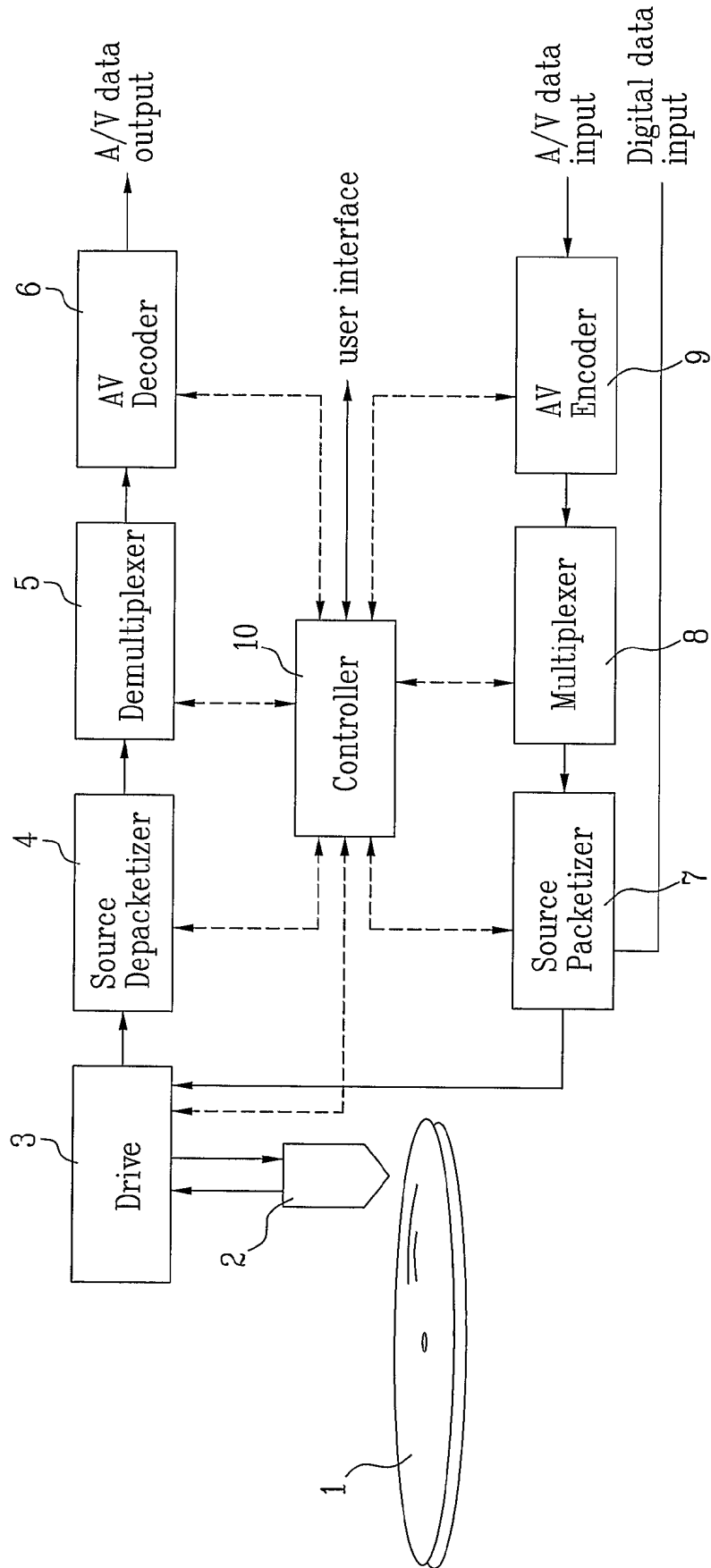

FIG. 6



## INTERNATIONAL SEARCH REPORT

International application No.  
PCT/KR 2004/001058

A. CLASSIFICATION OF SUBJECT MATTER G11B 20/10 According to International Patent Classification (IPC) or to both national classification and IPC		
B. FIELDS SEARCHED Minimum documentation searched (classification system followed by classification symbols) G11B 20/10, 20/12 Documentation searched other than minimum documentation to the extent that such documents are included in the fields searched G06F 12/14 Electronic data base consulted during the international search (name of data base and, where practicable, search terms used) WPI		
C. DOCUMENTS CONSIDERED TO BE RELEVANT		
Category*	Citation of document, with indication, where appropriate, of the relevant passages	Relevant to claim No.
A	US 2002136118 A1 (TAKAHASHI) 26 September 2002 (26.09.2002)  --	1,19,29,31
A	EP 0464811 A (MATSUSHITA) 8 January 1992 (08.01.1992)  -----	1,19,29,31
<input type="checkbox"/> Further documents are listed in the continuation of Box C. <input checked="" type="checkbox"/> See patent family annex.		
<p>* Special categories of cited documents:</p> <p>"A" document defining the general state of the art which is not considered to be of particular relevance</p> <p>"E" earlier application or patent but published on or after the international filing date</p> <p>"L" document which may throw doubts on priority claim(s) or which is cited to establish the publication date of another citation or other special reason (as specified)</p> <p>"O" document referring to an oral disclosure, use, exhibition or other means</p> <p>"P" document published prior to the international filing date but later than the priority date claimed</p> <p>"T" later document published after the international filing date or priority date and not in conflict with the application but cited to understand the principle or theory underlying the invention</p> <p>"X" document of particular relevance; the claimed invention cannot be considered novel or cannot be considered to involve an inventive step when the document is taken alone</p> <p>"Y" document of particular relevance; the claimed invention cannot be considered to involve an inventive step when the document is combined with one or more other such documents, such combination being obvious to a person skilled in the art</p> <p>"&amp;" document member of the same patent family</p>		
Date of the actual completion of the international search 7 July 2004 (07.07.2004)		Date of mailing of the international search report 31 August 2004 (31.08.2004)
Name and mailing address of the ISA/ AT <b>Austrian Patent Office</b> Dresdner Straße 87, A-1200 Vienna Facsimile No. +43 / 1 / 534 24 / 535		Authorized officer GRÖSSING G.  Telephone No. +43 / 1 / 534 24 / 386

INTERNATIONAL SEARCH REPORT  
Information on patent family members

International application No.  
PCT/KR 2004/001058

Patent document cited in search report			Publication date	Patent family member(s)		Publication date
EP	A	464811		DE	T 69127776T	1998-03-19
				DE	D 69127776D	1997-11-06
				US	A 5270877	1993-12-14
				EP	A 0464811	1992-01-08
				JP	A 4067471	1992-03-03
US	A	20021361	2002-09-26	JP	A 2002288937	2002-10-04
		18		CN	A 1376984	2002-10-30